

The new ZMorph VX Multitool 3D Printer

ZMorph VX is the most versatile and the most practical multitool 3D printer that you can put on a desk. With three different fabrication methods and dozens of available materials, ZMorph is designed to be your workhorse, versatile object making machine and a problem solver.



Foreword.

We've been making digital fabrication machines since 2013. Long enough to learn that quality, reliability and ease of use are the key for every creative business. That's why we bring the new ZMorph VX to the public - a workhorse, versatile object making machine, ready to prototype or mass produce as 3D printer, CNC cutter or laser engraver.

ZMorph is the state of the art engineering solution, addressing needs of designers, architects, electronics, makers, entrepreneurs and educators. Whether you want to make a fully functioning drone, a bluetooth speaker or a plastic enclosure for your project, ZMorph VX is a solution that is always up for the task.

If you're just interested in simple 3D printing - ZMorph Printing Set is the best way to start your additive manufacturing adventure, with features like autocalibration or 3-click printing. We've made it as easy as possible, so your path from 3D model to tangible object is short and painless.

And when you're ready for an upgrade - go to our shop or visit one of our resellers and choose among several interchangeable toolheads to bring new capabilities to life in your desktop manufacturing center. Two-material printing, laser engraving, CNC, or thick paste extrusion? Browse this brochure and decide which way you want to go.



Przemek Jaworski
ZMorph Founder

Interchangeable toolheads and worktables

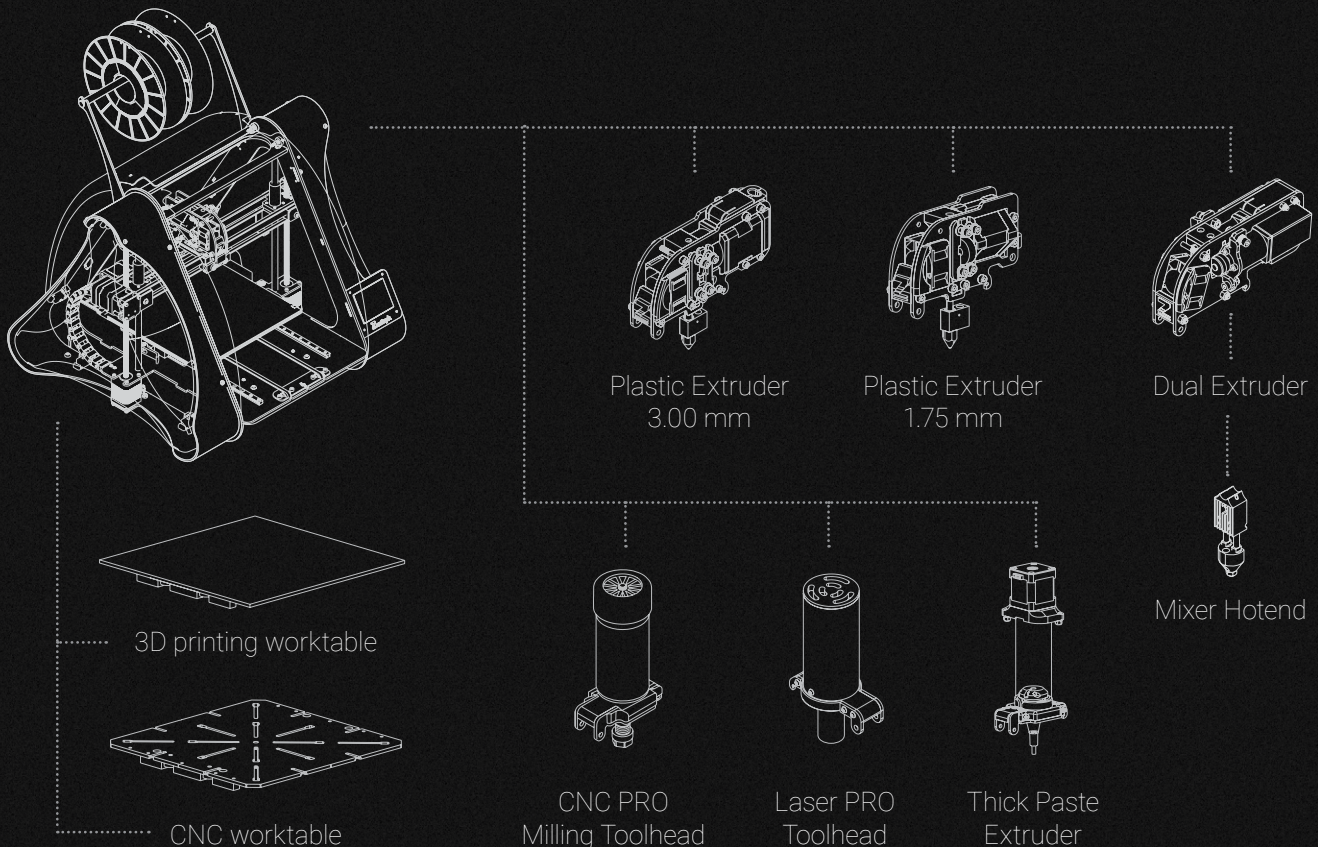

Top grade 3D printing.



MATERIALS FOR 3D PRINTING

- ABS and derivatives
- PLA and derivatives
- PVA
- ASA
- PET
- Nylon
- HIPS
- Thermochrome
- TPU
- Flex materials

MATERIALS FOR THICK PASTE PRINTING

- Chocolate
- Cookie dough
- Cream cheese
- Frosting
- Ceramics

3D PRINTING SPECIFICATION

- Mechanical positioning precision: 14 microns for X and Y axes, 0.6 microns for Z axis.
- Layer resolution: 50 - 400 microns.
- Enclosed build chamber with heated bromosilicate worktable.
- Max hotend temp.: 250 C.
- Max table temp.: 100 C.
- Interchangeable nozzles (excluding Dual Extruder): 0.2, 0.3, 0.4 mm.
- Interchangeable hotends (Dual Extruder).
- Working area: 250 x 235 x 165 mm.

TOOLHEADS



- Single Plastic Extruder 1.75
- Single Plastic Extruder 3.00



- Dual Extruder
- Thick Paste Extruder



Two-material 3D printing that keeps you ahead of the game.



Selective two-material 3D Printing

When single colored prints are not enough, reach for our two-material toolhead and add more realism to your creations.

Color blending

Mix two colors of the same material together to achieve eye-catching gradients or even completely new colors.

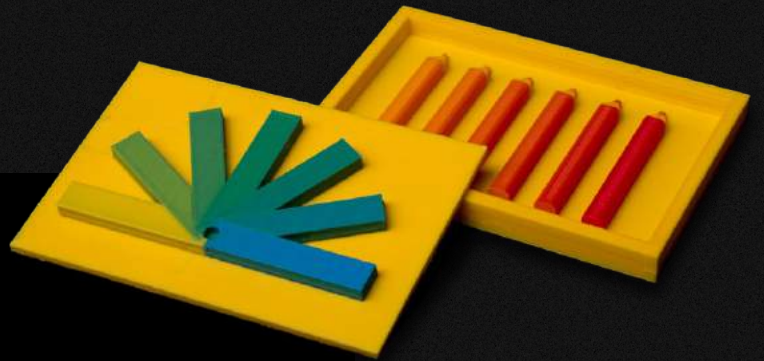
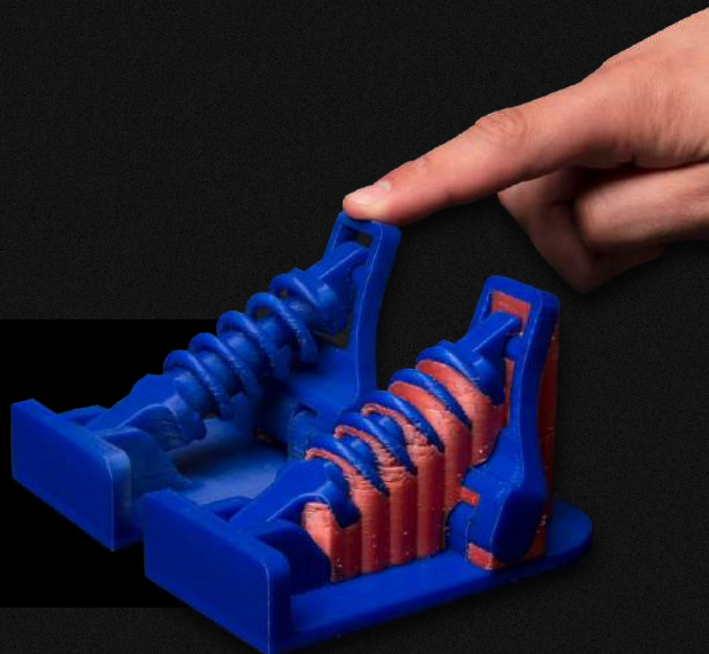

Image mapping

Enhance your models with complex multicolored patterns and rise above the average.

Printing with soluble support

Use PVA as support material and you're ready to print the most complex, intricate models, even with moving parts inside. Use water to clean the support and enjoy a smooth finish, hassle-free.





Easy to use, right out of the box.

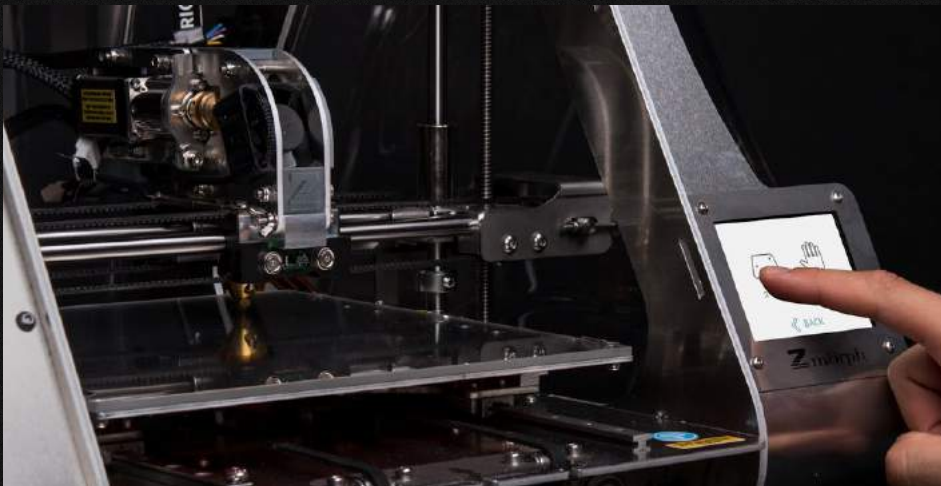

Autocalibration

Proper printer setup is crucial for getting the most out of any 3D printer, and we think this process should be automatic. That's why we've developed fully automatic calibration that remarkably improves user experience of working with a 3D printer.



Completely new Voxeler software

You'll be amazed by Voxeler's powerful possibilities and intuitive interface. We've improved speed, algorithms and usability, and we're serving it in a beautifully designed interface.



LCD touchscreen

This fast and responsive touchpanel with a completely new interface makes using a 3D printer feel like using a tablet.



Easy workflow switching

Switching the toolheads is easy and requires no more than a minute. Switching the worktables is even faster.



Heavy duty.

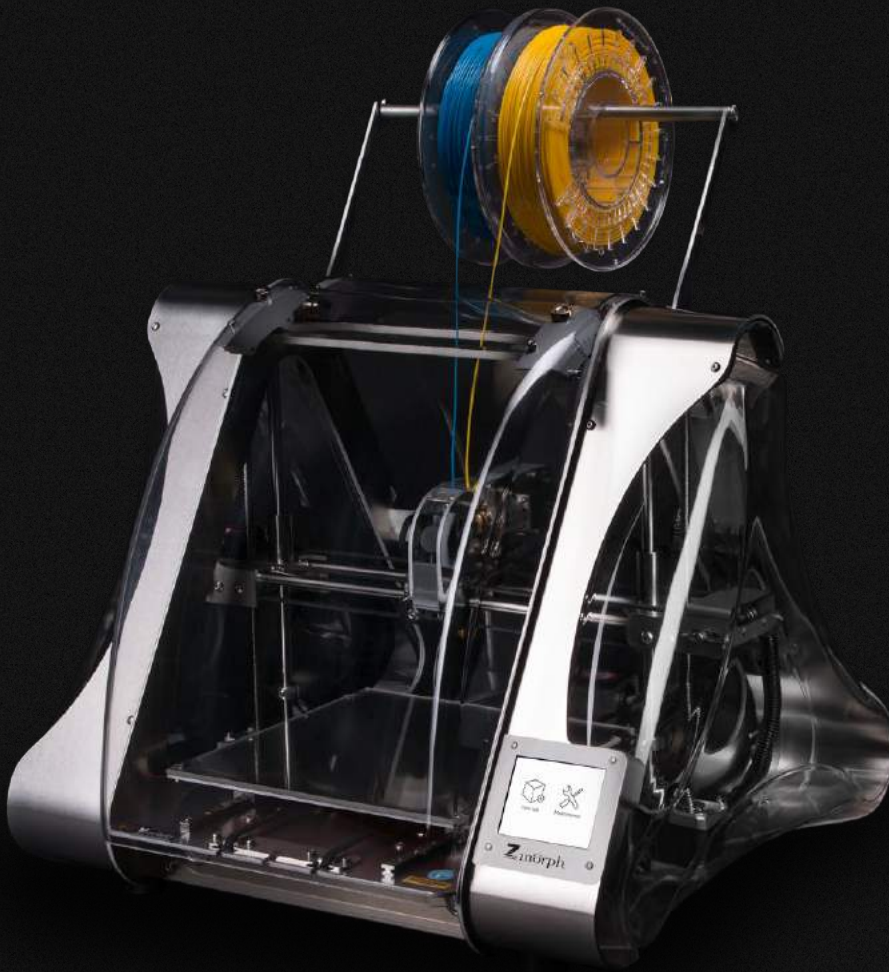

Built like a tank

ZMorph VX is designed to withstand high torque of CNC works and high speed of 3D printing. The machine's frame is composed of precisely cut, perfectly fitted aluminum and stainless steel, backed up by additional flat metal bars in construction nodes exposed to high tension. What's more, ZMorph VX has especially reinforced construction along the X axis and Y axis.

Enclosed build chamber

To ensure safety and cleanness during work, the build chamber is enclosed with see-through covers made out of PET. This solution also helps maintaining stable temperature during 3D printing. All electronics are protected by design from milling chips and other fabrication byproducts.

Only top quality components

From super flat borosilicate worktable, best-in-class linear bearings and linear guides, Omron endstops, to non-slip trapezoidal nuts on Z axis made out of high quality POM.

Double belt drive system

Most 3D printers rely on single belt drive system - ZMorph doubles that with 2 high quality fiberglass reinforced belts on the X and Y axes, tied with Gates Powergrip tensioning system. The result is stability and reliability above standards.

Modular two-material toolhead

Introducing Dual Extruder with interchangeable hotends. This unique hotend solution serves two purposes - first, it makes toolhead maintenance easier after many hours of heavy duty work. Second, it will allow you to equip Dual Extruder toolhead with other kinds of hotends, and get a completely new functionality for a fraction of the price.

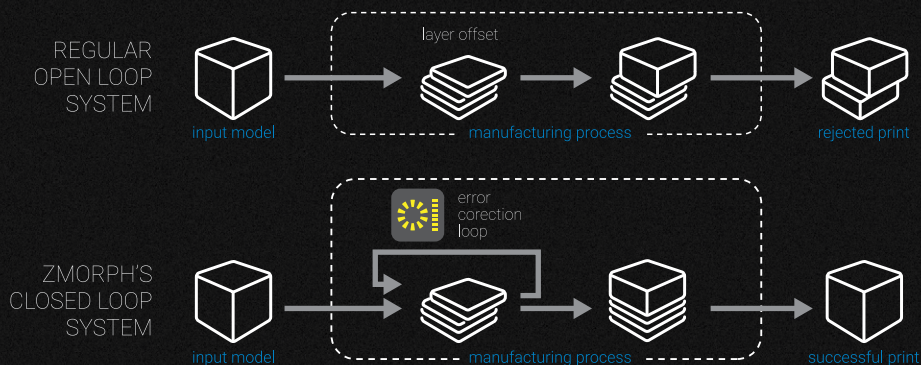

And there's so much more...

ZMorph VX is an exceptional 3D printer - but that's not the end of the story. ZMorph VX can transform into a CNC router, laser engraver, back to 3D printer and so on. Owning a ZMorph is like owning your own mini-factory.

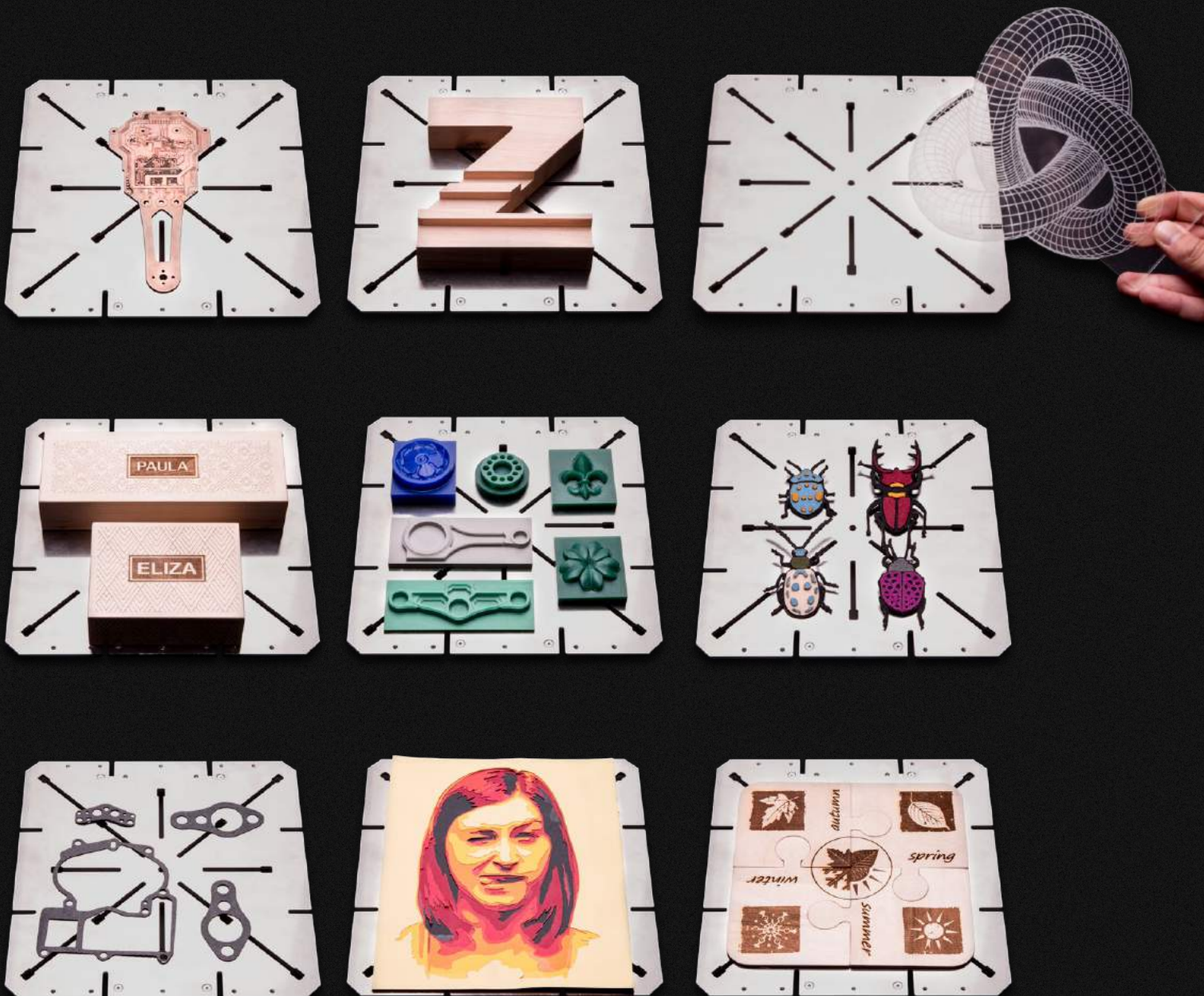



Access materials inaccessible to single-purpose 3D printers.



TOOLHEAD: CNC PRO



MATERIALS FOR CNC CUTTING AND ENGRAVING

- All kinds of wood
- HDPE
- Polycarbonate
- Acrylic glass
- Machining wax
- Modeling board
- Copper laminates (for PCBs)
- POM
- PVC foam
- Dibond-like composites

CNC TECH SPECS

- Working area: 250 x 235 x 85 mm.
- Mechanical positioning precision: 14 microns for X and Y axes, 0.6 microns for Z axis.
- ER-11 collet
- Default work speed: 5 mm/s
- Max work speed: 120 mm/s
- Double belt drive
- Enclosed build chamber and electronics

TOOLHEAD: LASER PRO



MATERIALS FOR LASER ENGRAVING

- All kinds of wood
- Leather
- Copper laminates (for PCBs)

MATERIALS FOR LASER CUTTING

- Paper
- Cardboard
- Felt
- Thin gasket materials

LASER TECH SPECS

- Working area: 250 x 235 x 85 mm.
- Mechanical positioning precision: 14 microns for X and Y axes, 0.6 microns for Z axis.
- Default work speed: 5 mm/s
- Max work speed: 120 mm/s

A 3D Printer Beyond 3D Printing.

Subtractive or additive manufacturing? With ZMorph VX you can have both. Enjoy your freedom of choice: 3D printing, CNC milling, laser engraving, or even a combination of all.



This fully functional drone was made entirely on ZMorph VX with all the ZMorph fabrication methods: 3D printing, CNC, and laser.

The electronics casing, propeller guards, and landing gear were 3D printed, the PCB board was etched with Laser PRO and then milled with CNC PRO, the frame was milled from lightweight and sturdy Dibond.



3D printed

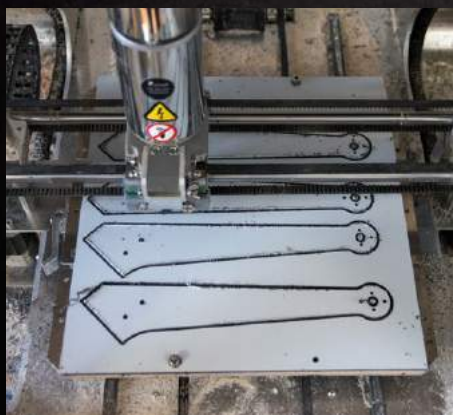

CNC milled

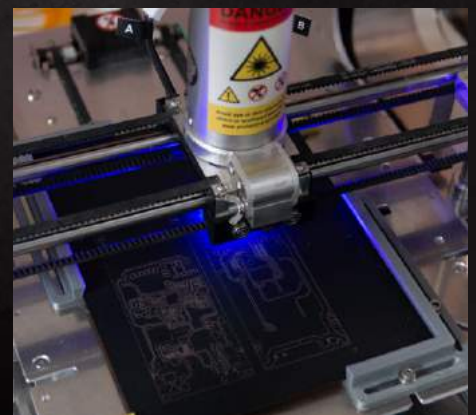

Laser engraved



Versatility is a smart investment.



Functional prototypes

With a ZMorph on your desk, you're prepared for any project. You're prepared to amaze, inspire, prototype, iterate, teach or even run your own business. Whether you're looking for a digital fabrication workhorse or an education aid, versatility is a smart investment.



Concept models

Tools, jigs and fixtures

Historical reconstruction

Signage and customization

Art and decor

Architectural models

Molds, castings

Lessons

Medical visualization aids

Research

Cosplay



End use parts and low volume production

Get inspired with amazing examples from the new ZMorph Catalog.

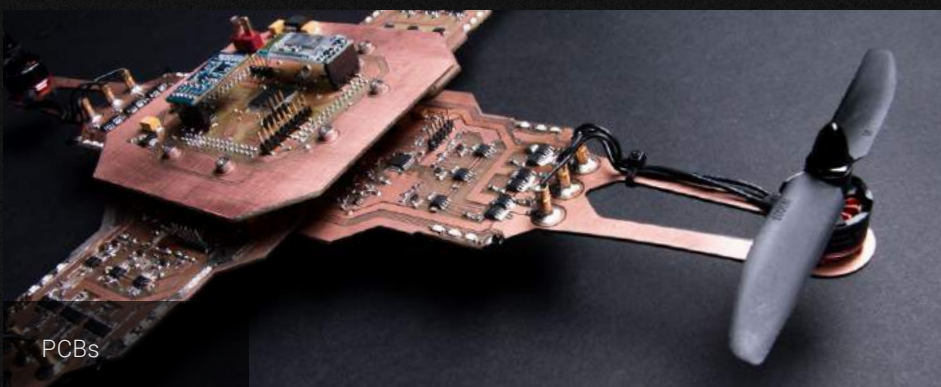

PCBs



zmorph3d.com/catalog





The all-in-one software. Meet the new Voxelizer.

ZMorph's original Voxelizer software is the intelligence behind the machine. It allows you to control all fabrications methods of the ZMorph VX and gives you access to the most advanced 3D printing capabilities.

Optimize your models with 3D filters. Make unprintable things printable with smart support structures. Create stunning prints with advanced multi-material algorithms, like image mapping. All thanks to voxelization process - that extra mile our software goes to give you and your ZMorph outstanding possibilities.



3D Printing, CNC and laser workflows



3D Filters



Texture mapping



Advanced preset control



Boolean operations



Voxelizer supports popular 3D mesh files, image files, vector data and DICOM medical files.



Supported OS:



Zmorph

www.zmorph3d.com

 /ZMorph3d

 @ZMorph3d

 /ZMorph3D

 @zmorph3d